

# **BODYGARD**

Industrial zone 26 st No 9 26101 Eskisehir-  
Turkey Phone +90 222 236 23 63 Fax: +90 222 236  
23 53  
[www.bodygard.com.tr](http://www.bodygard.com.tr)

▶ **INDEX**

The Advantages of disposable drapes, gowns and surgical packs .....	04-05
Material key .....	06
General surgery .....	07-09
Cardiovascular .....	09-10
Cardiology .....	11-12
Neurosurgery .....	12-13
Orthopedy .....	13-15
Obstetrics and Gynaecology .....	15-17
Urology .....	18-19
E.N.T. ....	19-20
Ophthalmic .....	21
Radiology .....	22
Dental .....	23
Sterile Drapes .....	23
Sterile Gowns .....	24
Non Sterile Gowns .....	24



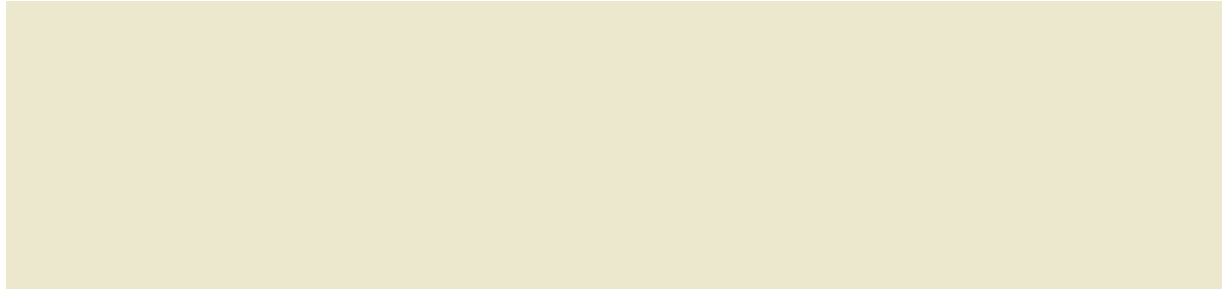

## **THE ADVANTAGES OF DISPOSABLE DRAPES GOWNS AND SURGICAL PACKS**

Disposable material applications become more widespread as compliance to health rules gain more importance in the world. The main advantages of disposable drapes, gowns and surgical packs are cost, hygiene and quality.

When analyzed in terms of cost point of view, multi-use drape, gown and drape packs compared to disposable materials create more costs such as energy, staff, water, waste water, stitching and forming, stain removal, washing, drying, folding, controlling, packing, resterilization, storage and transportation. The processes such as washing and drying bring about the costs of a separate labor, electricity and time for hospitals. When all of the above are taken into consideration, disposable equipments are more economical.

When analyzed in terms of hygiene point of view, disposable drape, gown and drape packs are products which are used as personal protection equipment to minimize virus contamination to patients and also to minimize health personnel exposure to pathogens especially passing through blood, and which are designed to be used to prevent infections by creating a barrier between sterile and non-sterile zones. Taking into consideration all the processes taking place from the production until the end user, disposable products are more reliable, more healthy, more economical and more environmental friendly in all aspects compared to multiple-use products.

When analyzed in terms of quality point of view, disposable drape, gown and drape packs are produced in compliance with the international standards. All the processes from raw material supply, production, packing, labeling, and sterilization until the delivery to the end user are done in the required conditions of international quality standards. Disposable products produced with high quality provide reliability to the user.

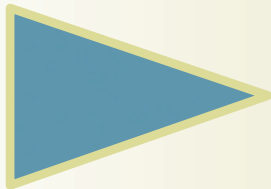

### **DOUBLE LAYER MATERIAL**

With its absorbing and liquid trapping property double layer material has become more widely used in surgical clothes. During the surgery, the top layer with the help of the highly absorbent material, quickly absorbs any type of liquid that comes onto the cloth and with the help of the film creating the bottom layer prevents absolute liquid penetration.

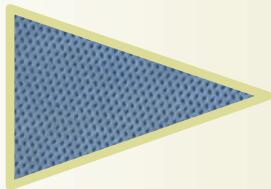

### **REPELLENT MATERIAL**

The repellent material which is the mostly used fabric structure in disposable gowns, consists of different layers bonded by thermal methods or with adhesives having different properties. The main characteristic of this material is to provide repellency by removing the liquid without absorption. The middle layer of the material functions as a barrier and it prevents unwanted liquid penetrations.

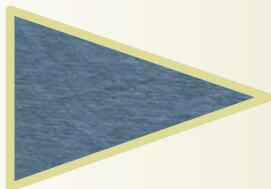

### **HIGH REPELLENT MATERIAL**

In the production of High repellent material which is a type of spunlace fabric consisting of generally a mixture of pulp and polyester fibre; the fibres are exposed to high pressure water which spins the fibres in order to obtain mechanical binding. High repellent material which is the most optimum material for the spunlace fabrics especially against bacterial transmission, is the most preferred spunlace fabric structure due to its skin comfort with its soft texture.

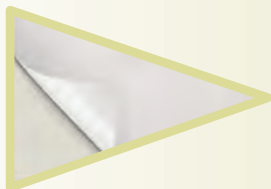

### **MEDICAL TAPES**



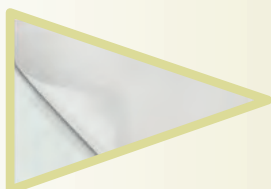





Medical tapes which have non-irritating characteristic to skin, are used for securing the cloth to the patient's skin or for creating a barrier around the surgery zone. It minimizes the microorganism transfer from or to the surgery zone.

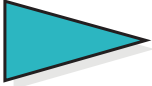
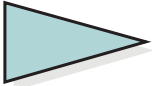
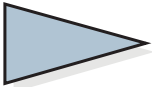
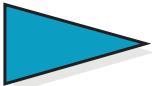
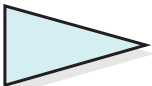

### **INCISION FILM**

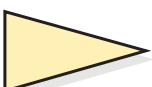
Medical film layer which has non-irritating characteristic to skin, helps to maintain good adhesion by adding it in between the clothes during surgery or by using it alone in the surgery zone. It also creates a barrier against infections.

## MATERIAL KEY

	<b>Double layer material</b> Drapes
	<b>High absorbent material</b> Drapes
	<b>Repellent material</b> Gowns
	<b>High repellent material</b> Gowns
	<b>Absorbent and impermeable material</b> Drapes and gowns
	<b>Elastic material</b> Drapes
	<b>Blue plastic material</b> Drapes and gowns
	<b>Transparent plastic material</b> Drapes
	<b>Incision film</b> Drapes
	<b>Medical tape</b> Drapes
	<b>Towel</b>
	<b>Wrap material</b>

The specified color card material key shows the fabric type and characteristics



# GENERAL SURGERY

## GEC161 GENERAL SURGERY DRAPE PACK

NO	CODE	PRODUCT NAME	SIZE	QUANTITY
1	32315251	Towel	40 x 40 cm	2
2	32081134	Mayo Table Cover	80 x 150 cm	1
3	32112130	Op-Tape	10 x 50 cm	1
4	31229130	Adhesive Side Drape	75 x 90 cm	2
5	312243130	Adhesive Foot Drape	175 x 180 cm	1
6	31244130	Adhesive Anesthesia Drape	150 x 240 cm	1
7	31735133	Equipment Table Cover	100 x 150 cm	1
8	32433174	Sterilization Wrap	100 x 100 cm	1

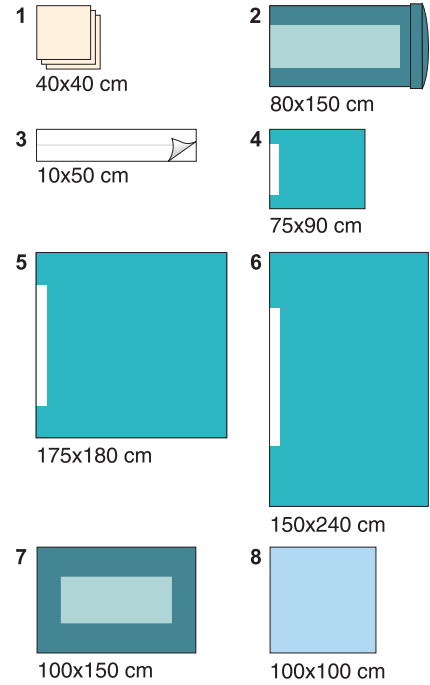

# GENERAL SURGERY

## GEC160 GENERAL SURGERY DRAPE PACK

NO	CODE	PRODUCT NAME	SIZE	QUANTITY
1	32315251	Towel	40 x 40 cm	6
2	11204172	Reinforced Gown	XL	2
3	11104172	Standard Gown	XL	2
4	32081134	Mayo Table Cover	80 x 150 cm	1
5	32112130	Op-Tape	10 x 50 cm	1
6	31229130	Adhesive Drape	75 x 90 cm	2
7	312243130	Adhesive Drape	175 x 180 cm	1
8	31244130	Adhesive Drape	150 x 240 cm	1
9	31735133	Equipment Table Cover	100 x 150 cm	1
10	32433174	Sterilization Wrap	100 x 100 cm	1

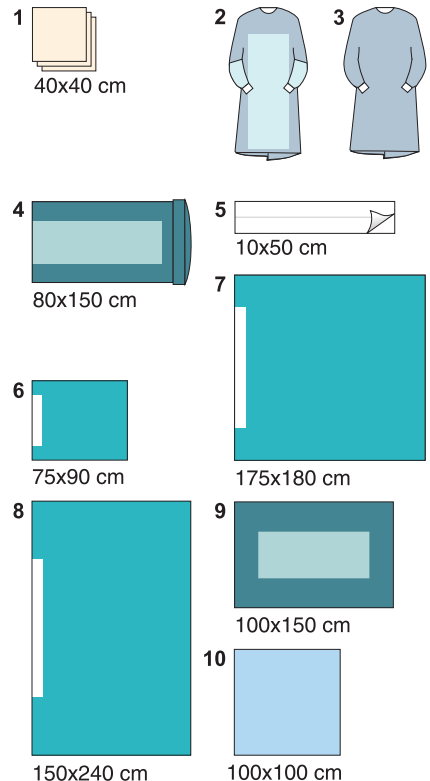

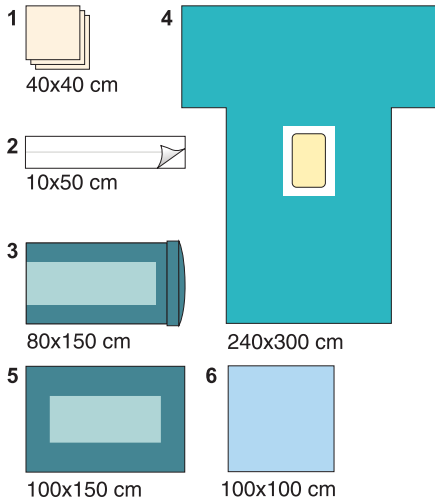

NO	CODE	PRODUCT NAME	SIZE	QUANTITY
1	32315251	Towel	40 x 40 cm	2
2	32112130	Op-Tape	10 x 50 cm	1
3	32081134	Mayo Table Cover	80 x 150 cm	1
4	314244130	Laparoscopy Drape (25 x 30 cm. hole)	240 x 300 cm	1
5	31735133	Equipment Table Cover	100 x 150 cm	1
6	32433174	Sterilization Wrap	100 x 100 cm	1

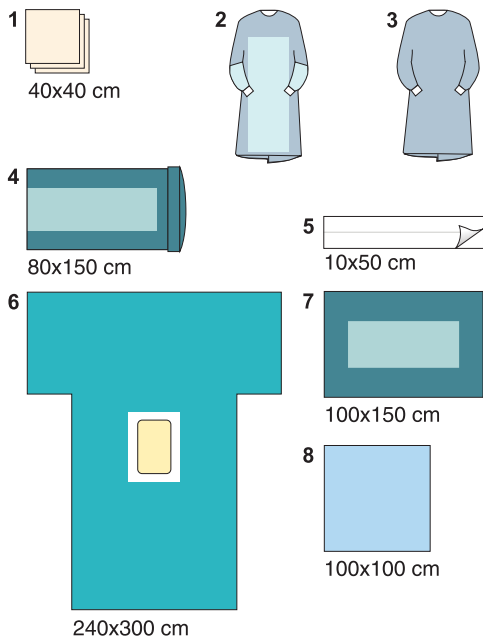

NO	CODE	PRODUCT NAME	SIZE	QUANTITY
1	32315251	Towel	40 x 40 cm	5
2	11204172	Reinforced Gown	XL	2
3	11104172	Standard Gown	XL	1
4	32081134	Mayo Table Cover	80 x 150 cm	1
5	32112130	Op-Tape	10 x 50 cm	1
6	314244130	Laparoscopy Drape (25 x 30 cm. hole)	240 x 300 cm	1
7	31735133	Equipment Table Cover	100 x 150 cm	1
8	32433174	Sterilization Wrap	100 x 100 cm	1



## GENERAL SURGERY

### GEC132 MINOR SURGICAL DRAPE PACK

NO	CODE	PRODUCT NAME	SIZE	QUANTITY
1	32315251	Towel	40 x 40 cm	3
2	11104172	Standard Gown	XL	1
3	53000001	Solution bowl	(100 cc ~ 1000 cc)	1
4	41200001	Sponge with Handle		1
5	31433130	Adhesive Aperture Drape (Ø 4 -15 cm)	100 x 100 cm	1
6	31735133	Equipment Table Cover	100 x 150 cm	1
7	32433174	Sterilization Wrap	100 x 100 cm	1

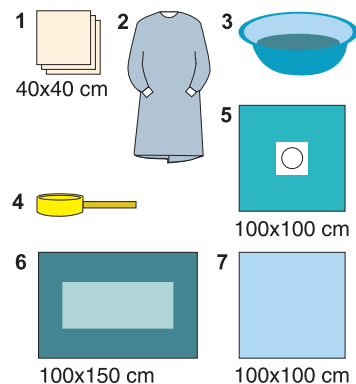

## CARDIOVASCULAR

### BYP149 BY-PASS DRAPE PACK

NO	CODE	PRODUCT NAME	SIZE	QUANTITY
1	32315251	Towel	40 x 40 cm	6
2	11204172	Reinforced Gown	XL	4
3	32081134	Mayo Table Cover	80 x 150 cm	1
4	32112130	Op-Tape	10 x 50 cm	2
5	32519147	Adhesive Bag	28 x 33 cm	2
6	31125130	Plain Drape	50 x 50 cm	4
7	33850130	Leg Cover		1 Pair
8	31552130	Split Bottom Drape	200 x 260 cm	1
9	316128130	Cardio Vascular Drape (31 x 38,5 cm. hole)	240 x 340 cm	1
10	31742133	Equipment Table Cover	150 x 200 cm	2
11	32433174	Sterilization Wrap	100 x 100 cm	1

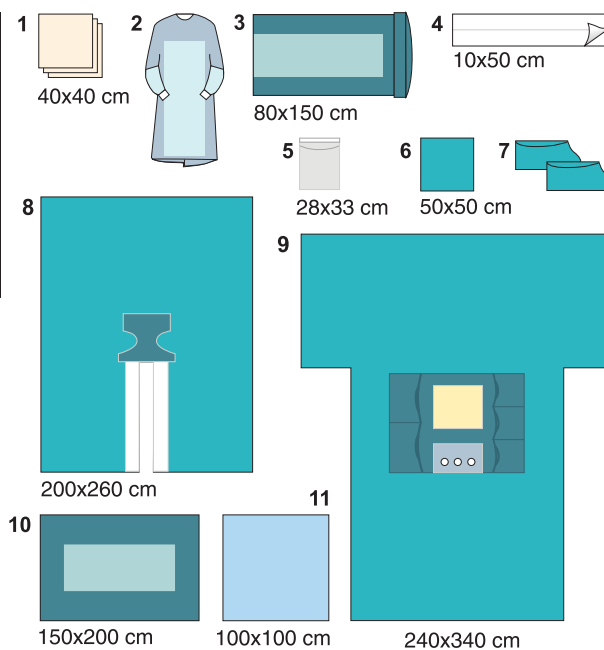

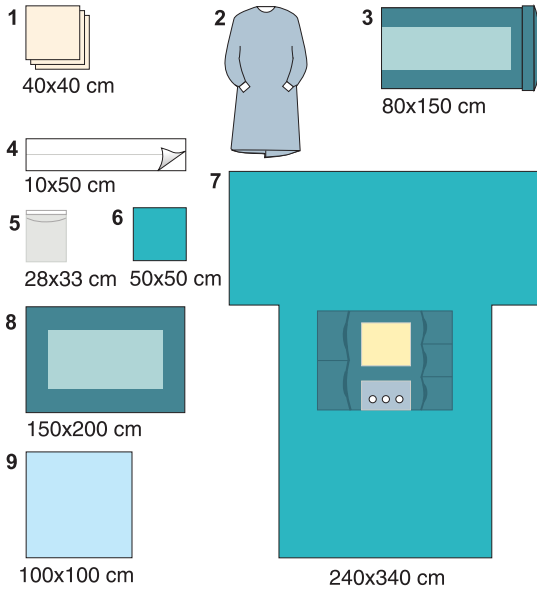

NO	CODE	PRODUCT NAME	SIZE	QUANTITY
1	32315251	Towel	40 x 40 cm	6
2	11204172	Standard Gown	XL	4
3	32081134	Mayo Table Cover	80 x 150 cm	1
4	32112130	Op-Tape	10 x 50 cm	2
5	32519147	Adhesive Bag	28 x 33 cm	2
6	31125130	Plain Drape	50 x 50 cm	4
7	316128130	Valve Drape (31 x 38.5 cm. hole)	240 x 340 cm	1
8	31742133	Equipment Table Cover	150 x 200 cm	2
9	32433174	Sterilization Wrap	100 x 100 cm	1

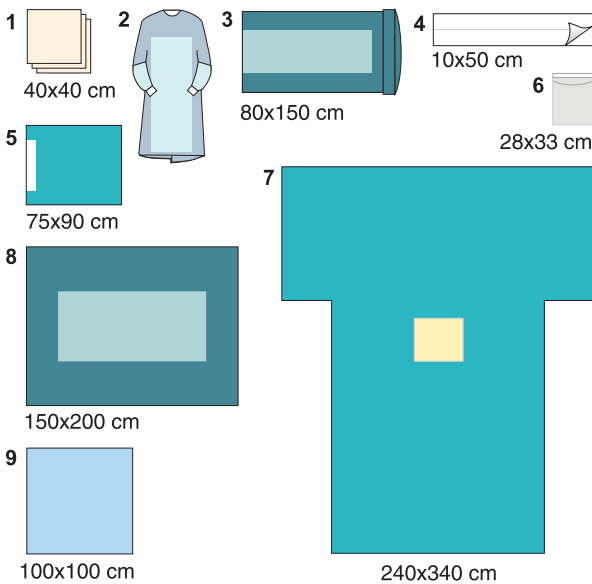

NO	CODE	PRODUCT NAME	SIZE	QUANTITY
1	32315251	Towel	40 x 40 cm	6
2	11204172	Reinforced Gown	XL	4
3	32081134	Mayo Table Cover	80 x 150 cm	1
4	32112130	Op-Tape	10 x 50 cm	2
5	31229130	Adhesive Drape	75 x 90 cm	1
6	32519147	Adhesive Bag	28 x 33 cm	2
7	316128130	Thoracic Drape (35 x 36 cm. hole)	240 x 340 cm	1
8	31742133	Equipment Table Cover	150 x 200 cm	2
9	32433174	Sterilization Wrap	100 x 100 cm	1

# CARDIOLOGY

## ANG115 ANGIOGRAPHY DRAPE PACK

NO	CODE	PRODUCT NAME	SIZE	QUANTITY
1	32315251	Towel	40 x 40 cm	4
2	11204172	Standard Gown	XL	2
3	41200001	Sponge with Handle		1
4	53000001	Solution bowl	(100 cc ~ 1000 cc)	2
5	32250142	Angio Tube Cover		1
6	32929158	Panel Cover		1
7	314127130	Femoral Angio Drape	150 x 300 cm	1
8	31735133	Equipment Table Cover	100 x 150 cm	1
9	32433174	Sterilization Wrap	100 x 100 cm	1

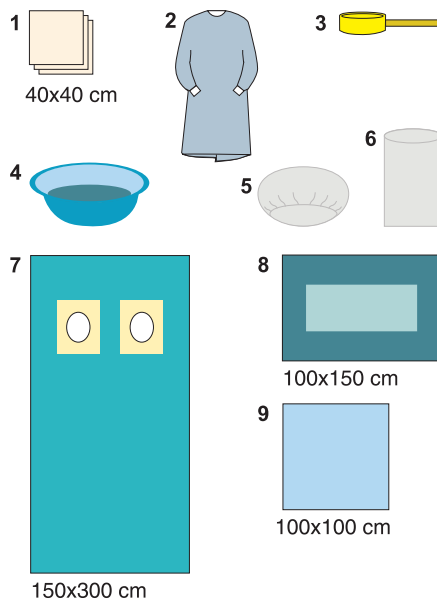

# CARDIOLOGY

## ANG128 RADIAL ANGIOGRAPHY DRAPE PACK

NO	CODE	PRODUCT NAME	SIZE	QUANTITY
1	32315251	Towel	40 x 40 cm	4
2	11104172	Standard Gown	XL	2
3	53000001	Solution bowl	(100 cc ~ 1000 cc)	2
4	41200001	Sponge with Handle		1
5	32250142	Angio Tube Cover		1
6	32929158	Panel Cover		1
7	31453130	Radial Angio Drape	200 x 300 cm	1
8	31735133	Equipment Table Cover	100 x 150 cm	1
9	32433174	Sterilization Wrap	100 x 100 cm	1

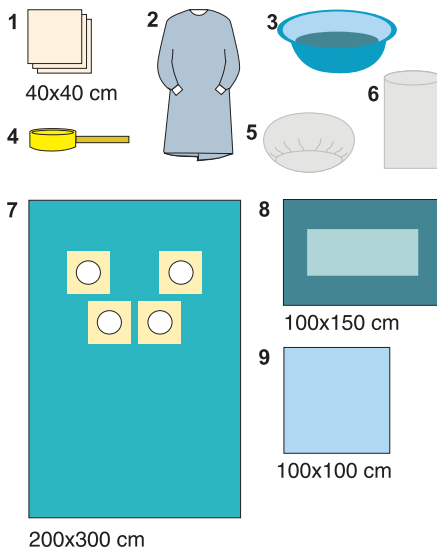

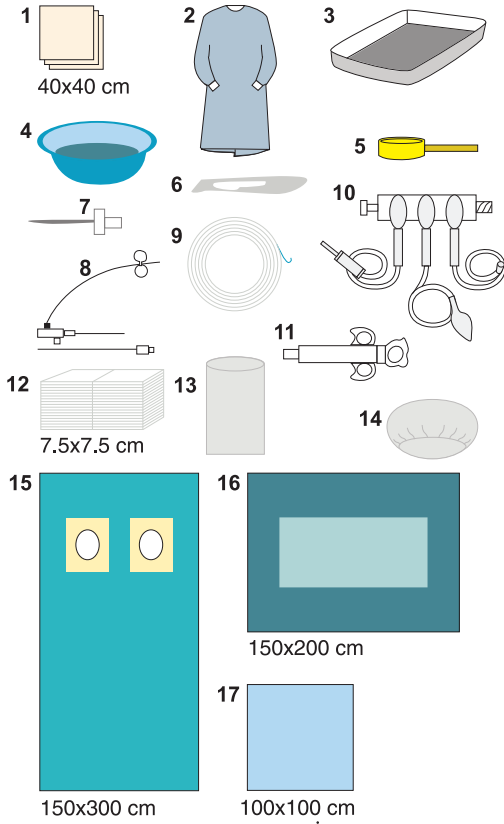

NO	CODE	PRODUCT NAME	SIZE	QUANTITY
1	32315251	Towel	40 x 40 cm	4
2	11104172	Standard Gown	XL	2
3	53300001	Tray		1
4	53000001	Solution bowl	(100 cc ~ 1000 cc)	2
5	41200001	Sponge with Handle		1
6	52700001	Scalpel	11	1
7	57400001	Arterial Needle 18 G		1
8	58200001	Introducer (5F / 6F / 7F)		1
9	59100001	Guide Wire (0.032" / 0.035" / 0.038")	150 cm	1
10	58800001	Manifold (3 way)		1
11	52300001	Coronary Syringe	10 / 12 cc	1
12	54000272	Surgical Gauze	7.5 x 7.5 cm	10
13	32929158	Panel Cover		1
14	32250142	Angio Tube Cover		1
15	314127130	Femoral Angio Drape	150 x 300 cm	1
16	31742133	Equipment Table Cover	150 x 200 cm	1
17	32433174	Sterilization Wrap	100 x 100 cm	1

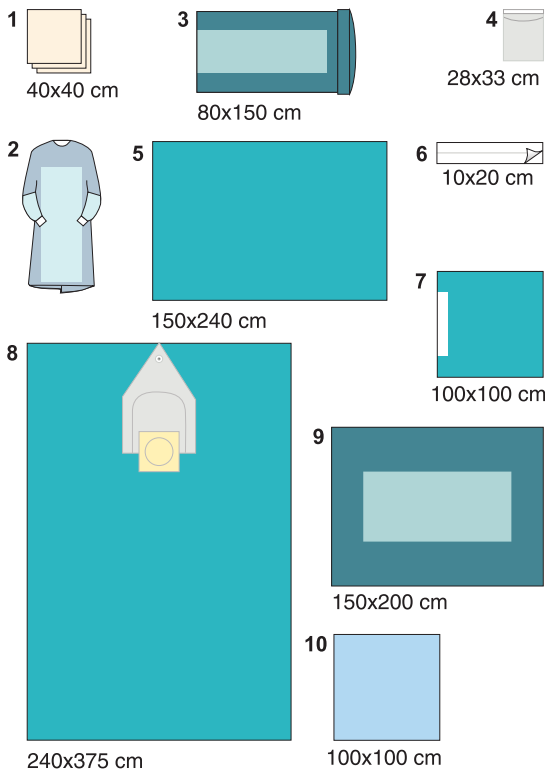

NO	CODE	PRODUCT NAME	SIZE	QUANTITY
1	32315251	Towel	40 x 40 cm	6
2	11204172	Reinforced Gown	XL	4
3	32081134	Mayo Table Cover	80 x 150 cm	1
4	32519147	Adhesive Bag	28 x 33 cm	2
5	31144130	Plain Drape	150 x 240 cm	3
6	321142130	Op-Tape	10 x 20 cm	6
7	31233130	Adhesive Drape	100 x 100 cm	4
8	316141130	Craniotomy Drape with pouch	240 x 375 cm	1
9	31742133	Equipment Table Cover	150 x 200 cm	2
10	32433174	Sterilization Wrap	100 x 100 cm	1

# NEUROSURGERY

## NRJ111 SPINAL DRAPE PACK

NO	CODE	PRODUCT NAME	SIZE	QUANTITY
1	32315251	Towel	40 x 40 cm	6
2	11204172	Reinforced Gown	XL	4
3	32081134	Mayo Table Cover	80 x 150 cm	1
4	31244130	Adhesive Drape	150 x 240 cm	1
5	31233130	Adhesive Drape	100 x 100 cm	4
6	31144130	Plain Drape	150 x 240 cm	1
7	31453130	Schunt Drape (20 x 50 cm. hole)	200 x 300 cm	1
8	31742133	Equipment Table Cover	150 x 200 cm	1
9	32433174	Sterilization Wrap	100 x 100 cm	1

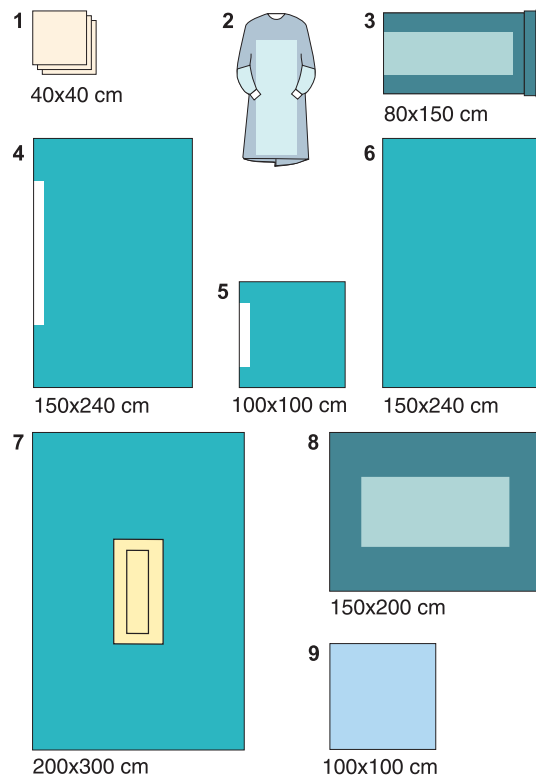

# ORTHOPEDEY

## ART139 ARTHROSCOPY DRAPE PACK

NO	CODE	PRODUCT NAME	SIZE	QUANTITY
1	32315251	Towel	40 x 40 cm	5
2	11204172	Reinforced Gown	XL	3
3	32583138	X-Ray Cassette Bag		2
4	51000001	Elastic Bandage		1
5	32112130	Op-Tape	10 x 50 cm	2
6	33165130	Stockinet	36 x 75 cm	1
7	316245130	Extremity Drape with pouch	240 x 320 cm	1
8	31742133	Equipment Table Cover	150 x 200 cm	1
9	32433174	Sterilization Wrap	100 x 100 cm	1

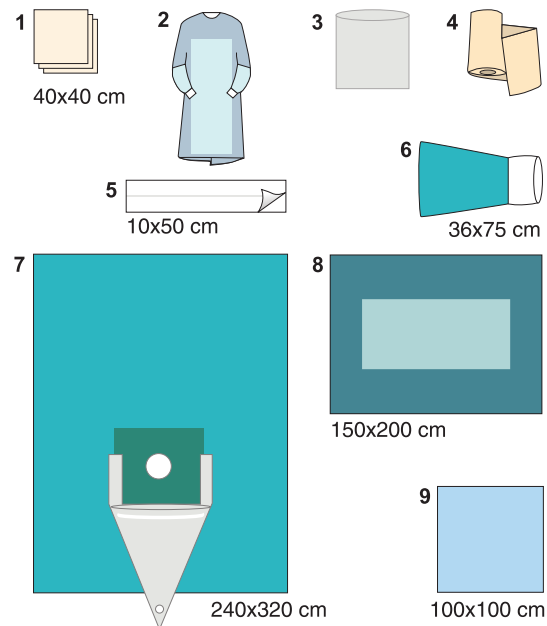

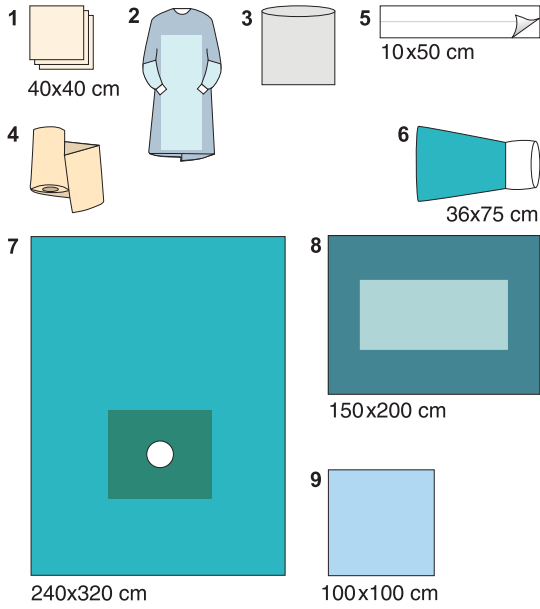

NO	CODE	PRODUCT NAME	SIZE	QUANTITY
1	32315251	Towel	40 x 40 cm	5
2	11204172	Reinforced Gown	XL	3
3	32583138	X-Ray Cassette Bag		2
4	51000001	Elastic Bandage		1
5	32112130	Op-Tape	10 x 50 cm	2
6	33165130	Stockinet	36 x 75 cm	1
7	314245130	Extremity Drape	240 x 320 cm	1
8	31742133	Equipment Table Cover	150 x 200 cm	1
9	32433174	Sterilization Wrap	100 x 100 cm	1

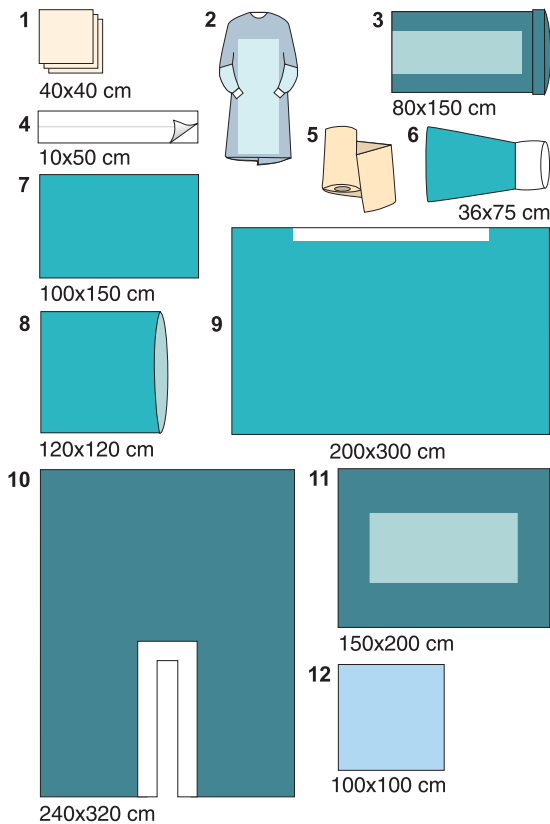

NO	CODE	PRODUCT NAME	SIZE	QUANTITY
1	32315251	Towel	40 x 40 cm	6
2	11204172	Reinforced Gown	XL	4
3	32081134	Mayo Table Cover	80 x 150 cm	1
4	32112130	Op-Tape	10 x 50 cm	2
5	51000001	Elastic Bandage		1
6	33165130	Stockinet	36 x 75 cm	1
7	31135130	Plain Drape	100 x 150 cm	2
8	31837130	Leg Cover	120 x 120 cm	1
9	31253130	Adhesive Drape	200 x 300 cm	1
10	315245130	Adhesive U Split Drape	240 x 320 cm	1
11	31742133	Equipment Table Cover	150 x 200 cm	2
12	32433174	Sterilization Wrap	100 x 100 cm	1

# ORTHOPEDY

## VRT185 VERTEBRA DRAPE PACK

NO	CODE	PRODUCT NAME	SIZE	QUANTITY
1	32315251	Towel	40 x 40 cm	6
2	11204172	Reinforced Gown	XL	4
3	32081134	Mayo Table Cover	80 x 150 cm	1
4	31244130	Adhesive Drape	150 x 240 cm	1
5	31233130	Adhesive Drape	100 x 100 cm	4
6	31144130	Plain Drape	150 x 240 cm	1
7	31453130	Vertebra Drape (20 x 50 cm.hole)	200 x 300 cm	1
8	31742133	Equipment Table Cover	150 x 200 cm	1
9	32433174	Sterilization Wrap	100 x 100 cm	1

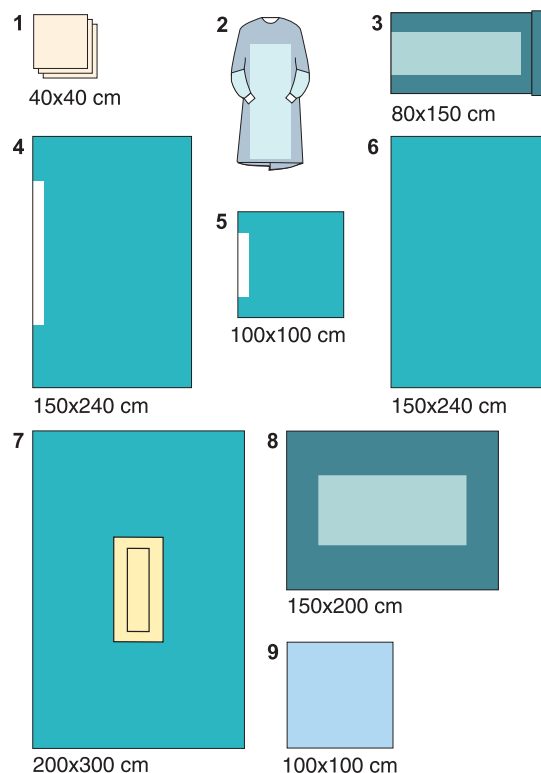

# OBSTETRICS AND GYNAECOLOGY

## DOG111 DELIVERY DRAPE PACK

NO	CODE	PRODUCT NAME	SIZE	QUANTITY
1	32315251	Towel	40 x 40 cm	5
2	11204172	Reinforced Gown	XL	2
3	11104172	Standard Gown	XL	1
4	31178251	Baby Drape	60 x 60 cm	1
5	31830130	Leg Cover	75 x 120 cm	2
6	312231130	Patient Upper Drape	75 x 150 cm	1
7	31135130	Patient Bottom Drape with pouch	100 x 150 cm	1
8	31735133	Equipment Table Cover	100 x 150 cm	1
9	32433174	Sterilization Wrap	100 x 100 cm	1

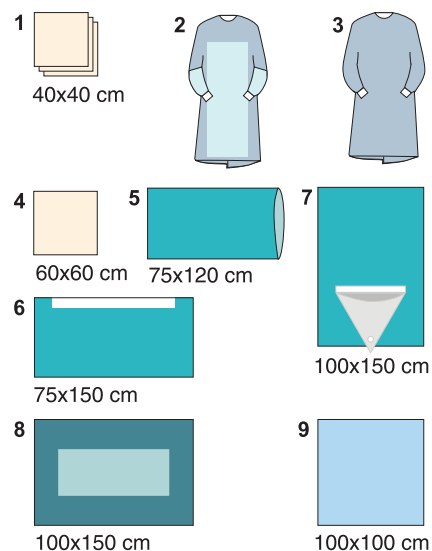



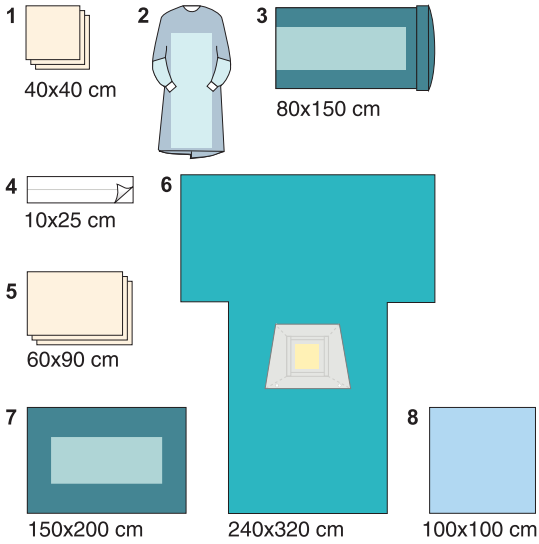

NO	CODE	PRODUCT NAME	SIZE	QUANTITY
1	32315251	Towel	40 x 40 cm	5
2	11204172	Reinforced Gown	XL	3
3	32081134	Mayo Table Cover	80 x 150 cm	1
4	32173130	Op-Tape	10 x 25 cm	2
5	31161320	Baby Drape	60 x 90 cm	1
6	316245130	Absorbent Cesarean Drape with Pouch	240 x 320 cm	1
7	31742133	Equipment Table Cover	150 x 200 cm	1
8	32433174	Sterilization Wrap	100 x 100 cm	1

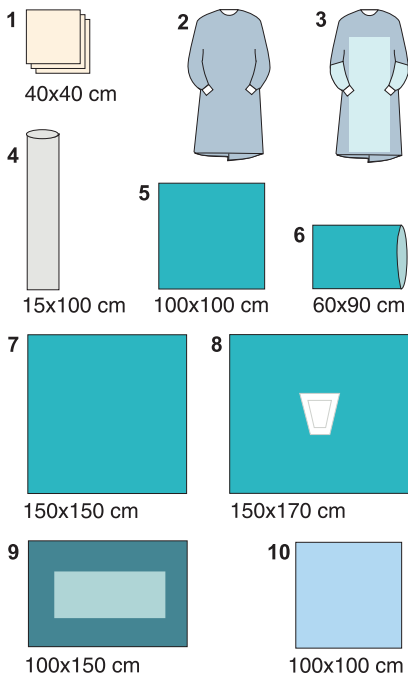

NO	CODE	PRODUCT NAME	SIZE	QUANTITY
1	32315251	Towel	40 x 40 cm	4
2	11104172	Standard Gown	XL	1
3	11204172	Reinforced Gown	XL	1
4	32968138	Ultrasound Cover	15 x 100 cm	1
5	31133130	Plain Drape	100 x 100 cm	1
6	31961130	Leg Cover	60 x 90 cm	1 Pair
7	31166130	Plain Drape	150 x 150 cm	1
8	31458130	Adhesive Aperture O.P.U. Drape	150 x 170 cm	1
9	31735133	Equipment Table Cover	100 x 150 cm	1
10	32433174	Sterilization Wrap	100 x 100 cm	1

## OBSTETRICS AND GYNAECOLOGY

### IVF141 O.P.U. DRAPE PACK

NO	CODE	PRODUCT NAME	SIZE	QUANTITY
1	32315251	Towel	40 x 40 cm	4
2	11104172	Standard Gown	XL	2
3	31278139	Adhesive Transparent Drape	60 x 60 cm	1
4	31961130	Leg Cover	60 x 90 cm	1 Pair
5	311150130	Plain Drape	90 x 90 cm	1
6	314134130	Adhesive Aperture O.P.U. Drape	130 x 150 cm	1
7	31735133	Equipment Table Cover	100 x 150 cm	1
8	32433174	Sterilization Wrap	100 x 100 cm	1

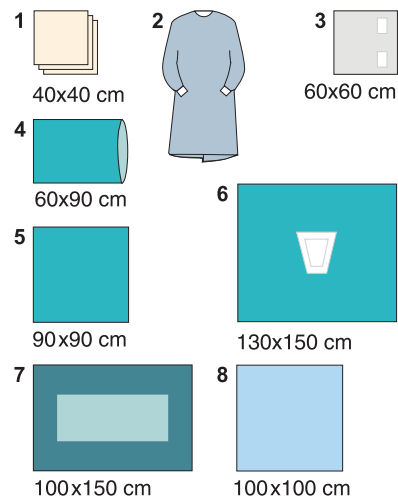

## OBSTETRICS AND GYNAECOLOGY

### IVF142 E.T. DRAPE PACK

NO	CODE	PRODUCT NAME	SIZE	QUANTITY
1	311150130	Plain Drape	90 x 90 cm	1
2	31428130	Adhesive Aperture Drape (Ø 6 - 14 cm)	75 x 80 cm	1
3	32427174	Sterilization Wrap	75 x 75 cm	1

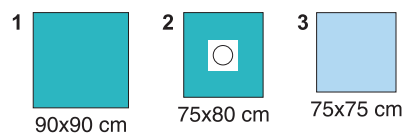

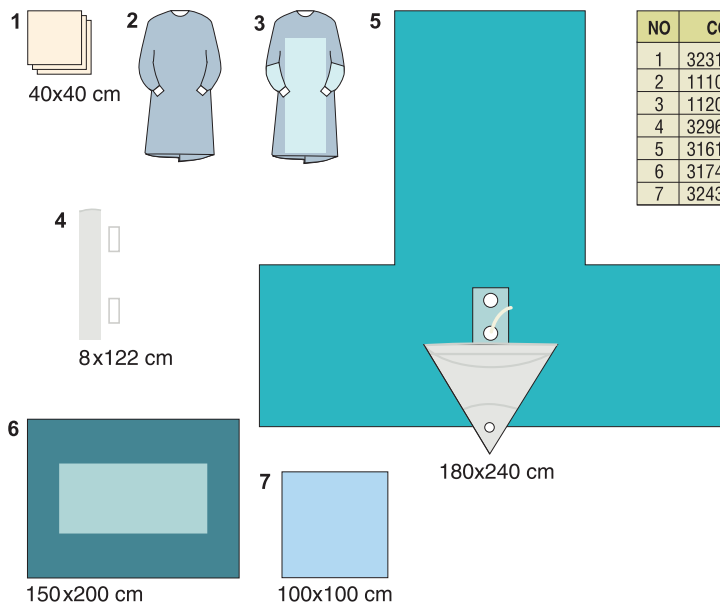

NO	CODE	PRODUCT NAME	SIZE	QUANTITY
1	32315251	Towel	40 x 40 cm	4
2	11104172	Standard Gown	XL	1
3	11204172	Reinforced Gown	XL	1
4	32969135	Tube Cover	8 x 122 cm	1
5	316124130	Tur Drape with pouch	180 x 240 cm	1
6	31742133	Equipment Table Cover	150 x 200 cm	1
7	32433174	Sterilization Wrap	100 x 100 cm	1

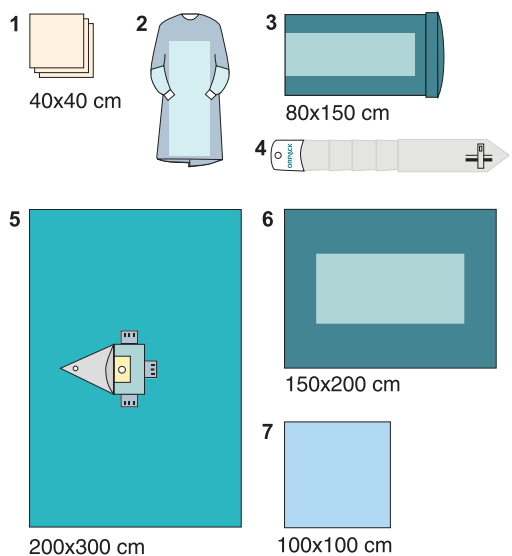

NO	CODE	PRODUCT NAME	SIZE	QUANTITY
1	32315251	Towel	40 x 40 cm	4
2	11204172	Reinforced Gown	XL	2
3	32081134	Mayo Table Cover	80 x 150 cm	1
4	329239141	Camera Cover	13.5 x 200 / 250 cm	1
5	31653130	Percutan Drape with pouch	200 x 300 cm	1
6	31742133	Equipment Table Cover	150 x 200 cm	1
7	32433174	Sterilization Wrap	100 x 100 cm	1

NO	CODE	PRODUCT NAME	SIZE	QUANTITY
1	32315251	Towel	40 x 40 cm	4
2	11204172	Reinforced Gown	XL	2
3	31924130	Leg Cover	60 x 115 cm	1 Pair
4	31129130	Plain Drape	75 x 90 cm	1
5	313231130	Cystoscopy Drape	75 x 150 cm	1
6	31735133	Equipment Table Cover	100 x 150 cm	1
7	32433174	Sterilization Wrap	100 x 100 cm	1

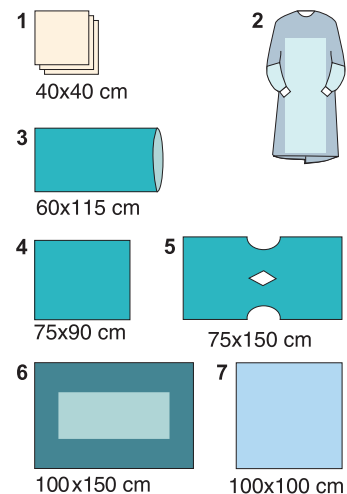

## E.N.T.

### KBB113 HEAD AND NECK DRAPE PACK

NO	CODE	PRODUCT NAME	SIZE	QUANTITY
1	32315251	Towel	40 x 40 cm	5
2	11204172	Reinforced Gown	XL	2
3	11104172	Standard Gown	XL	1
4	32112130	Op-Tape	10 x 50 cm	1
5	32081134	Mayo Table Cover	80 x 150 cm	1
6	31229130	Adhesive Drape	75 x 90 cm	1
7	31545130	Split Head and Neck Drape	150 x 250 cm	1
8	31735133	Equipment Table Cover	100 x 150 cm	1
9	32433174	Sterilization Wrap	100 x 100 cm	1

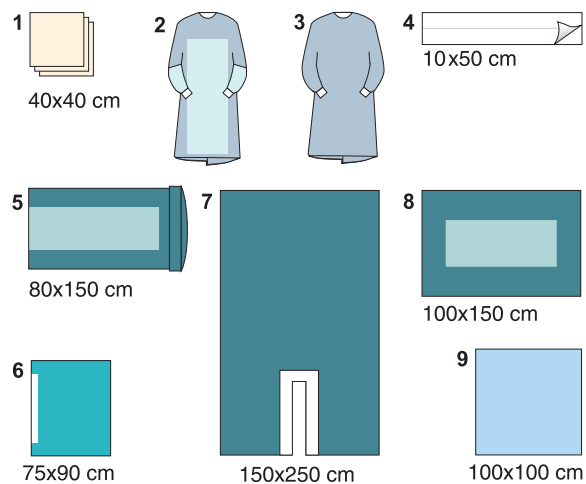

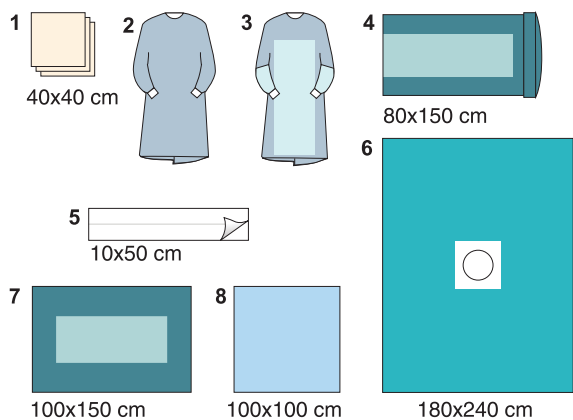

NO	CODE	PRODUCT NAME	SIZE	QUANTITY
1	32315251	Towel	40 x 40 cm	5
2	11104172	Standard Gown	XL	1
3	11204172	Reinforced Gown	XL	2
4	32081134	Mayo Table Cover	80 x 150 cm	1
5	32112130	Op-Tape	10 x 50 cm	1
6	314124130	Adhesive Aperture Drape (Ø 6 - 14 cm)	180 x 240 cm	1
7	31735133	Equipment Table Cover	100 x 150 cm	1
8	32433174	Sterilization Wrap	100 x 100 cm	1

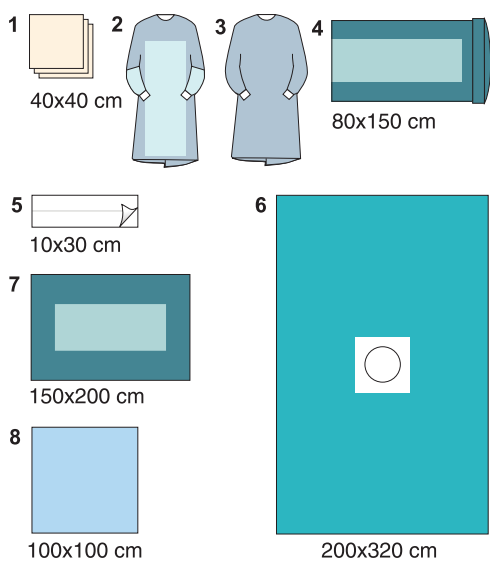

NO	CODE	PRODUCT NAME	SIZE	QUANTITY
1	32315251	Towel	40 x 40 cm	5
2	11204172	Reinforced Gown	XL	2
3	11104172	Standard Gown	XL	1
4	32081134	Mayo Table Cover	80 x 150 cm	1
5	321161130	Op-Tape	10 x 30 cm	2
6	31482130	Thyroid Drape (Ø 6 - 14 cm hole)	200 x 320 cm	1
7	31742133	Equipment Table Cover	150 x 200 cm	1
8	32433174	Sterilization Wrap	100 x 100 cm	1

# OPHTHALMIC

## GOZ120 EYE DRAPE PACK

NO	CODE	PRODUCT NAME	SIZE	QUANTITY
1	32315251	Towel	40 x 40 cm	4
2	11104172	Standard Gown	XL	2
3	31637130	Eye Drape with pouch	120 x 120 cm	1
4	31735133	Equipment Table Cover	100 x 150 cm	1
5	32433174	Sterilization Wrap	100 x 100 cm	1

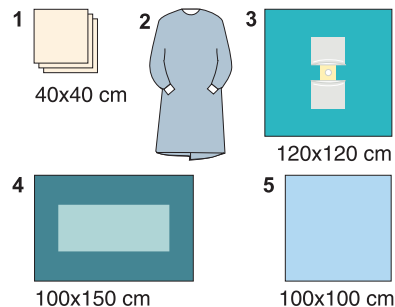

# OPHTHALMIC

## GOZ130 EYE DRAPE PACK

NO	CODE	PRODUCT NAME	SIZE	QUANTITY
1	32315251	Towel	40 x 40 cm	4
2	11104172	Standard Gown	XL	2
3	32081134	Mayo Table Cover	80 x 150 cm	1
4	31144130	Plain Drape	150 x 220 cm	1
5	31643130	Eye Drape with pouch	150 x 180 cm	1
6	31735133	Equipment Table Cover	100 x 150 cm	1
7	32433174	Sterilization Wrap	100 x 100 cm	1

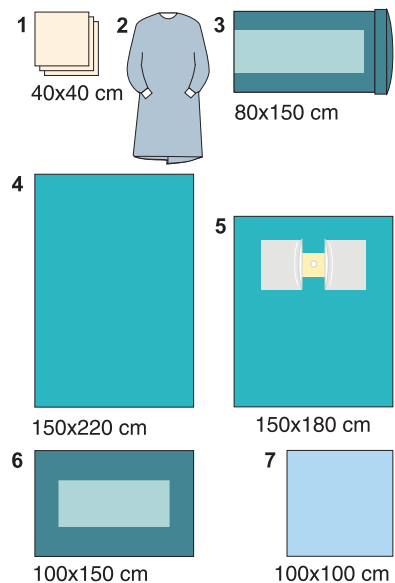

# OPHTHALMIC

## EYE DRAPES

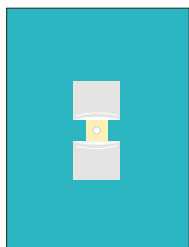

100x130 cm  
Eye Drape  
with double pouch  
Code: 31634130

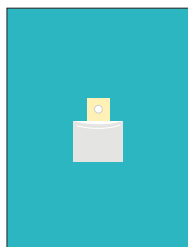

100x130 cm  
Eye Drape  
with pouch  
Code: 31634130

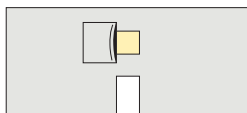

60x120 cm  
Left Eye Drape  
with pouch  
Code: 316182139

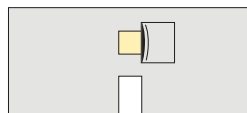

60x120 cm  
Right Eye Drape  
with pouch  
Code: 316182139

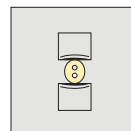

50x50 cm  
Lasik Drape  
with pouch  
Code: 31625139



50x50 cm  
Lasik  
Drape  
Code: 31425130

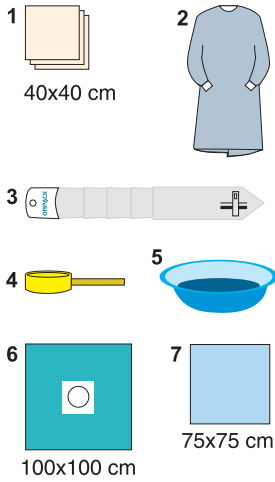

NO	CODE	PRODUCT NAME	SIZE	QUANTITY
1	32315251	Towel	40 x 40 cm	4
2	11104172	Standard Gown	XL	2
3	329239141	Camera Cover	13.5 x 200 / 250 cm	1
4	41200001	Sponge with Handle		1
5	53100001	Solution bowl	500 cc	1
6	31433130	Adhesive Aperture Drape	100 x 100 cm	1
7	32427174	Sterilization Wrap	75 x 75 cm	1

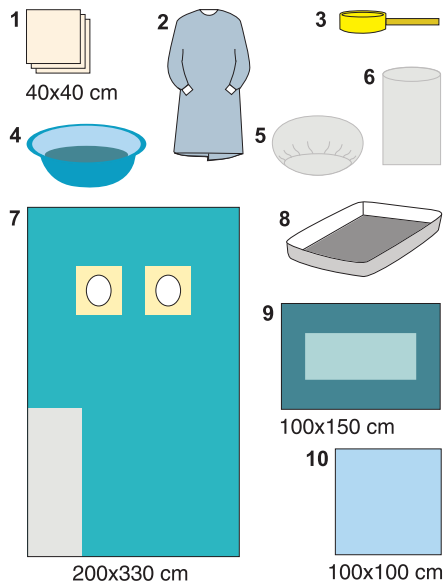

NO	CODE	PRODUCT NAME	SIZE	QUANTITY
1	32315251	Towel	40 x 40 cm	4
2	11104172	Standard Gown	XL	2
3	41200001	Sponge with Handle		1
4	53000001	Solution bowl	(100 cc ~ 1000 cc)	2
5	32250142	Angio Tube Cover		1
6	32929158	Panel Cover		1
7	314230130	Angio Drape	200 x 330 cm	1
8	53300001	Tray		1
9	31735136	Equipment Table Cover	100 x 150 cm	1
10	32433174	Sterilization Wrap	100 x 100 cm	1



NO	CODE	PRODUCT NAME	SIZE	QUANTITY
1	32315251	Towel	40 x 40 cm	1
2	31286172	Reflector Drape	15 x 15 cm	2
3	32519147	Waste bag	28 x 33 cm	1
4	32969135	Tube Cover	8 x 122 cm	2
5	31129130	Patient Upper Drape	75 x 90 cm	1
6	31735133	Equipment Table Cover	100 x 150 cm	1

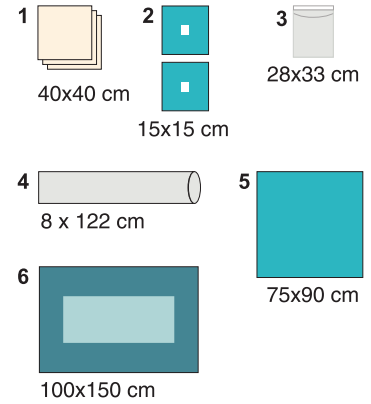

STERILE DRAPEs

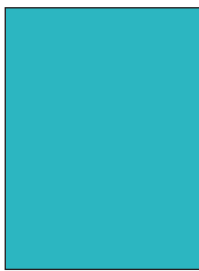

150x200 cm  
**Plain Drape**  
Code: 31142130



150x200 cm  
**Adhesive Drape**  
Code: 31242130

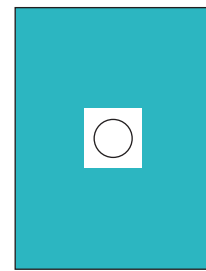

150x200 cm  
**Adhesive Aperture Drape**  
Code: 31442130



80x150 cm  
**Mayo Table Cover**  
Code: 32081134



100x150 cm  
**Equipment Table Cover**  
Code: 31735133

## STERILE GOWNS

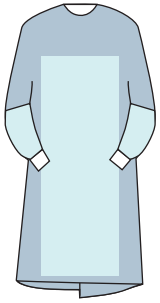

**Reinforced Gown**  
Code: 11204172

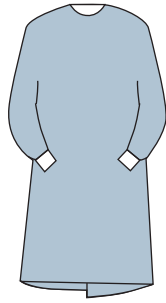

**Standard Gown**  
Code: 11104172

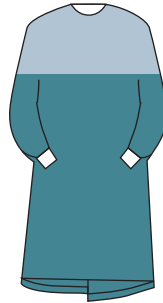

**Urology Gown**  
Code: 11350172



Repellent material



High repellent material



Absorbent and impermeable material



Blue plastic material

## NON STERILE GOWNS

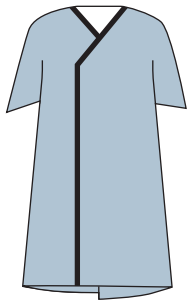

**Patient Gown  
(Front coupling)**  
Code: 21150114

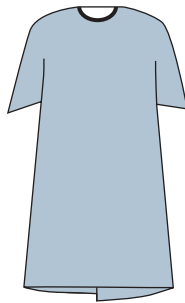

**Patient Gown  
(Back coupling)**  
Code: 21450114

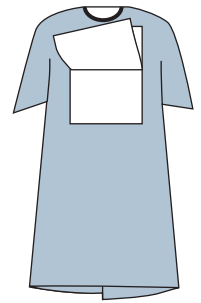

**Mammography Gown**  
Code: 21550114

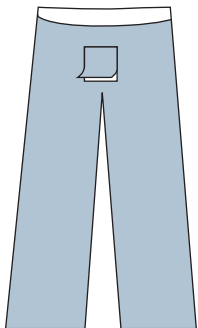

**Colonoscopy Pants**  
Code: 22750114

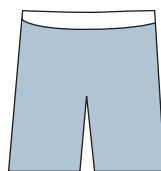

**Short**  
Code: 23950114

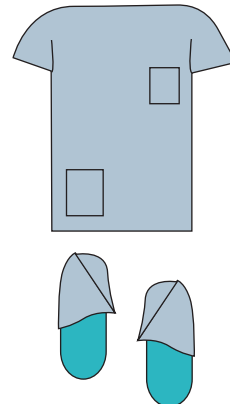

**Shirt and pant set**  
Code: 21950114

